



BIOMEDICAL

R-138i

BIOMEDICAL REFRIGERATOR

With a compact design, this undercounter fits perfectly beneath your work bench, providing a storage solution that is ideal for places where space is limited.



DIMENSIONS		VALUE
Outer Dimension HxWxD		825x595x642
Inner Dimension HxWxD		676x475x495
Weight Gross/Net, kg		56 / 45
Material inner cabinet		ABS
Material outer cabinet		Painted Steel
Insulation thickness		50
Insulation type		Polyurethane with Cyclopentane
Air distribution		Dynamic
Mobility		Standard: Adjustable Feet - Option: Castors
Refrigerant, Type / gram		R600a / 47
Variable Speed Compressor		Yes - Adaptive Cooling Technology
Number of probes		4
CONTROLLER		VALUE
Controller		i-Care, Touch screen
Controller language		EN, DE, FR
USB Connection		Yes
Logging		Data, Alarms & Events
Temperature graph		Yes
High/Low temp. Alarm		Yes
Open door alarm		Yes
Probe failure alarm		Yes
Power failure alarm		Yes
STORAGE		VALUE
Volume, Gross/Net, L		138 / 117
Shelves, Full/Half		2 / 1
Shelf material		Perforated Alu
FEATURES		VALUE
Lock		Yes
LED light		Yes
Battery Backup for Controller, 24h		Yes
Safety Thermostat		Yes
Porthole		Yes - Ø 20 mm
Dry Contact		Yes
Reference bottle		Yes
Door		Solid
Door Features		Automatic: Closure < 90° - Hold Closure > 90°
Door Reversibility		Yes



BIOMEDICAL

R-138i

BIOMEDICAL REFRIGERATOR

With a compact design, this undercounter fits perfectly beneath your work bench, providing a storage solution that is ideal for places where space is limited.

Voltage/Frequency	Voltage/Hz	230V/50-60Hz
Max Ambient	°C	35°C
Max Humidity	% rh	75%
PERFORMANCE		
PERFORMANCE	UNIT	VALUE
All data in RT20°C		
Temperature Range	°C	2 to 20
Uniformity in performance - difference between top and bottom	°C	+/- 0,4
Pull down time	Minutes	30 min to 6°C
Hold over time	Minutes	108 min to 10°C
Noise	dB	44
Energy 24 hours	kWh/24h	0,334 kWh/24h set 5°C
Energy year	kWh/year	121,9kWh/y set 5°C
Instant Power Consumption	kW	PD 0,080/Stable 0,025
Heat Rejection	W	46
U-Value	W/m ² K	0,59
COOLING COMPONENTS		
		VALUE
Refrigerant/Amount (gram)		R600a/47gr
Number of compressors	pcs	1
Varibel speed compressor	Yes/No	Yes
Internal air distribution (type of)		Dual Air Stream
Evaporator Fan	Yes/No/Variable	Yes
Condenser Fan	Yes/No/Variable	No
Number of probes	pcs	4
Defrost	Yes/No	Yes - automatic
FEATURES		
		VALUE
Safety thermostat	y/n/optional	Yes
Lock	y/n	Yes
LED light	y/n	Yes
Battery Back Up For Controller	y/n/optional	Yes - 24h
Porthole	y/n - Ømm	Yes - Ø 20mm
Dry contact	y/n	Yes
Castors	y/n/optional	Optional
Door	glass/solid	Solid
Reference Bottle	y/n/optional	Yes
Door closure	y/n/optional	Yes
Door reversibility	y/n	Yes
Automatic Hold 90°C	y/n	Yes
Vacum ventil + VIP (Vacum panel)	y/n	No



R-138i

BIOMEDICAL REFRIGERATOR

With a compact design, this undercounter fits perfectly beneath your work bench, providing a storage solution that is ideal for places where space is limited.

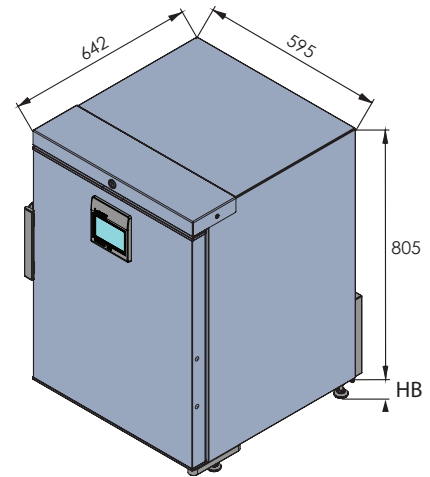
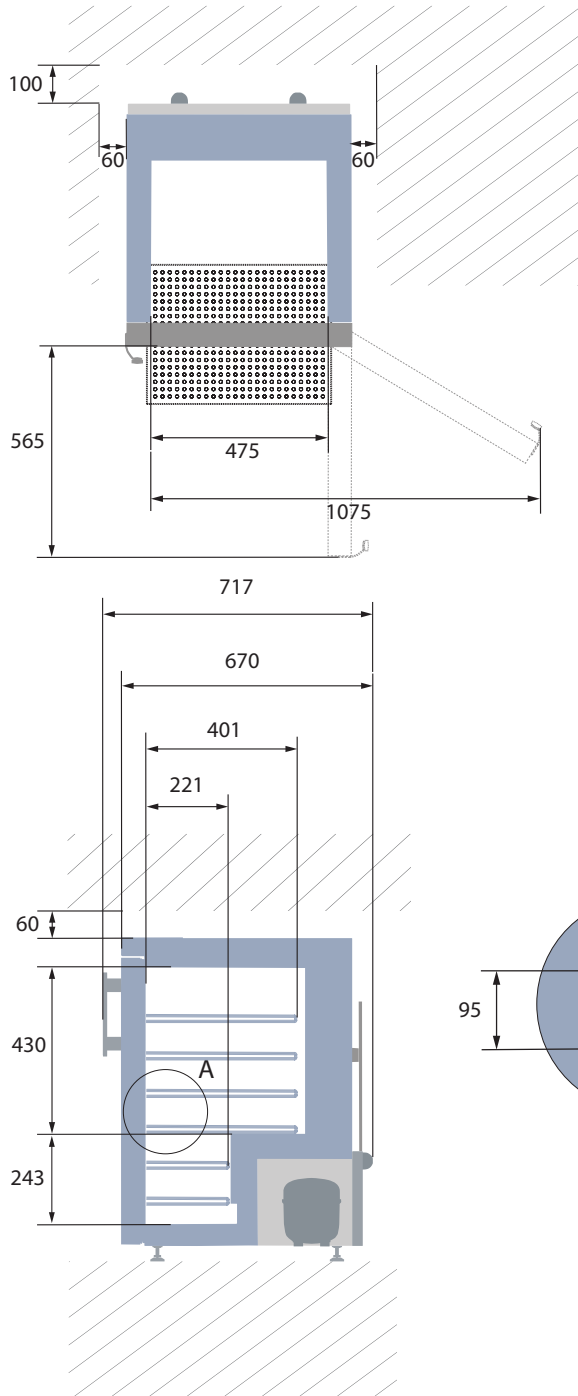

All measurements in mm.

HB: Height of base
(HB is adjustable when given value is xx-xx)

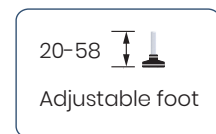
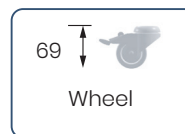



R-138i

BIOMEDICAL REFRIGERATOR

With a compact design, this undercounter fits perfectly beneath your work bench, providing a storage solution that is ideal for places where space is limited.

SENSOR POSITION

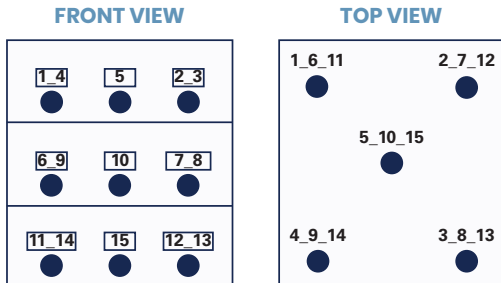

MODEL R-138i

Test type	15-point test
Test environment	Controlled conditions, empty cabinet
Ambient temperature	20°C
Humidity	60%
Set-point	5°C
Sensor used	25gr tinned brass formed as a cylinder with a diameter of 15,2 mm
Installation	Appliance installed according to instruction manual conditions
Refrigerant	R600a

SENSOR TEMPERATURE

Sensor position	P1	P2	P3	P4	P5	P6	P7	P8	P9	P10	P11	P12	P13	P14	P15
Max	5,2	5	5,1	5,6	5,1	5	4,8	5,1	5,3	5	5	4,8	5,2	5,1	4,8
Avg.	5	4,9	5	5,4	5	4,9	4,7	4,9	5,1	4,9	4,9	4,6	4,8	4,9	4,6
Min.	4,9	4,8	4,9	5,3	4,8	4,7	4,6	4,7	5	4,7	4,7	4,4	4,6	4,8	4,4

WARM UP & PULL DOWN

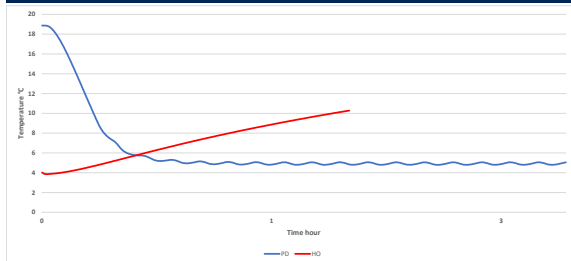

CYCLIC OPERATION

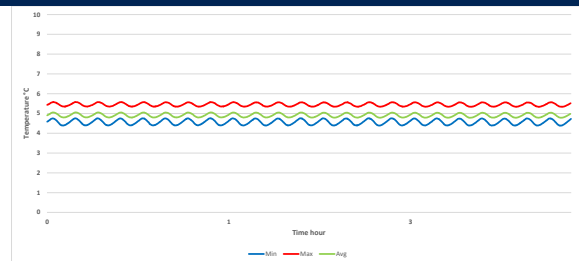

TYPICAL PERFORMANCE IN AMBIENT 20°C - EMPTY CABINET

Avg. cabinet temperature	4,9°C
Uniformity	+/- 0,4°C
Stability in avg.	0,1°C
1 min. door open recovery to 6°C avg. temperature	8 min.
Cycle rate on/off	4 / 6,5 min.
Duty cycle	37,9%
Energy consumption	0,33 kWh/day
Pull down time to 6°C avg. temperature	30 min.
Hold over time from 5°C to 10°C	108 min.
Sample temperature does not exceed	8°C
Heat rejection	46 W